

BIBFRAME Update Forum
ALA Annual Conference 2018
New Orleans

From MARC to BIBFRAME in the SHARE-VDE project

Tiziana Possemato
Casalini Libri - @Cult



SHARE

Virtual

Discovery

Environment

Introduction and overall project goals



What is SHARE-VDE?

SHARE-VDE is an initiative driven by the library community to establish processes to move the LAM traditional data to the new linked data frontier.

SHARE-VDE aims to establish an **effective working environment** for the use of linked data in the library context and beyond.

The project **enriches library data** with additional information and relationships, previously unexpressed under MARC, and it converts bibliographic and authority data in linked data.

It also creates a **virtual discovery platform** with the three-layered structure of the **BIBFRAME** data model, to simplify the human's data consuming.



Who is responsible for it?

SHARE-VDE is a collaborative endeavour based on the requirements and perceptions of libraries, developed by:

- **Casalini Libri**, provider of bibliographic and authority data as member of the Program for Cooperative Cataloguing
- **@Cult**, provider of ILS, Discovery tools and Semantic web solutions for the cultural heritage sector

with initial input and active participation from **16 North American Research Libraries**.

The initiative is governed by the library community.



SHARE-VDE overall goals

The main areas of the SHARE-VDE project:

- **Enrichment** of MARC record with URIs
- **Conversion from MARC to RDF** using the BIBFRAME vocabulary (and other additional ontologies as needed)
- **Data publication** according to the **BIBFRAME** data model
- Batch/automated **data updating** procedures
- Batch/automated **data dissemination** to libraries
- Progressive implementation of further **use cases** in the priority order defined by the community

The SHARE-VDE portal (www.share-vde.org)

Browse

SHARE Virtual Environment

Discovery

Person/Work

Italiano Info Contacts

Go to Publications

Person Work Publishers Subject

Search Person/Family/Corporate body

EXPAND ALL CLOSE ALL

▼ This person in

- WIKIDATA
- LIBRARY OF CONGRESS
- WorldCat Identities
- data.bnf.fr
- VI AF



Vivaldi, Antonio, 1678-1741
ID: 20355

Works

▼ Other name forms

- Vivaldi, Antonio, 1678-1741
- Вивальди, А. 1678-1741 АНТОНИО
- Vivaldi, Antonio, 1680-1741
- 1678-1741, אנטוניו, ויולדי
- Vivaldi, Antonio, sac., 1678-1741
- Vivaldi, Antonio
- ...(other forms)

▼ Bibliography

(Click title to search on Google)

3 quartets for two violins, viola, and cello (with bass ad libitum)

...(other titles)

Wikipedia

SELECT ALL

UNCHECKED ALL

EXPAND ALL CLOSE ALL

▼ A-C

<input type="checkbox"/> Alla caccia, alla caccia	<input type="checkbox"/> Amadeus	<input type="checkbox"/> Biondina in gondoleta
<input type="checkbox"/> Chamber music	<input type="checkbox"/> Cimento dell'armonia e dell'invenzione	<input type="checkbox"/> Classical music library
<input type="checkbox"/> Concertos	<input type="checkbox"/> Concertos pour mandoline	

▼ D-E

SHARE-VDE process overview



The SHARE-VDE processes

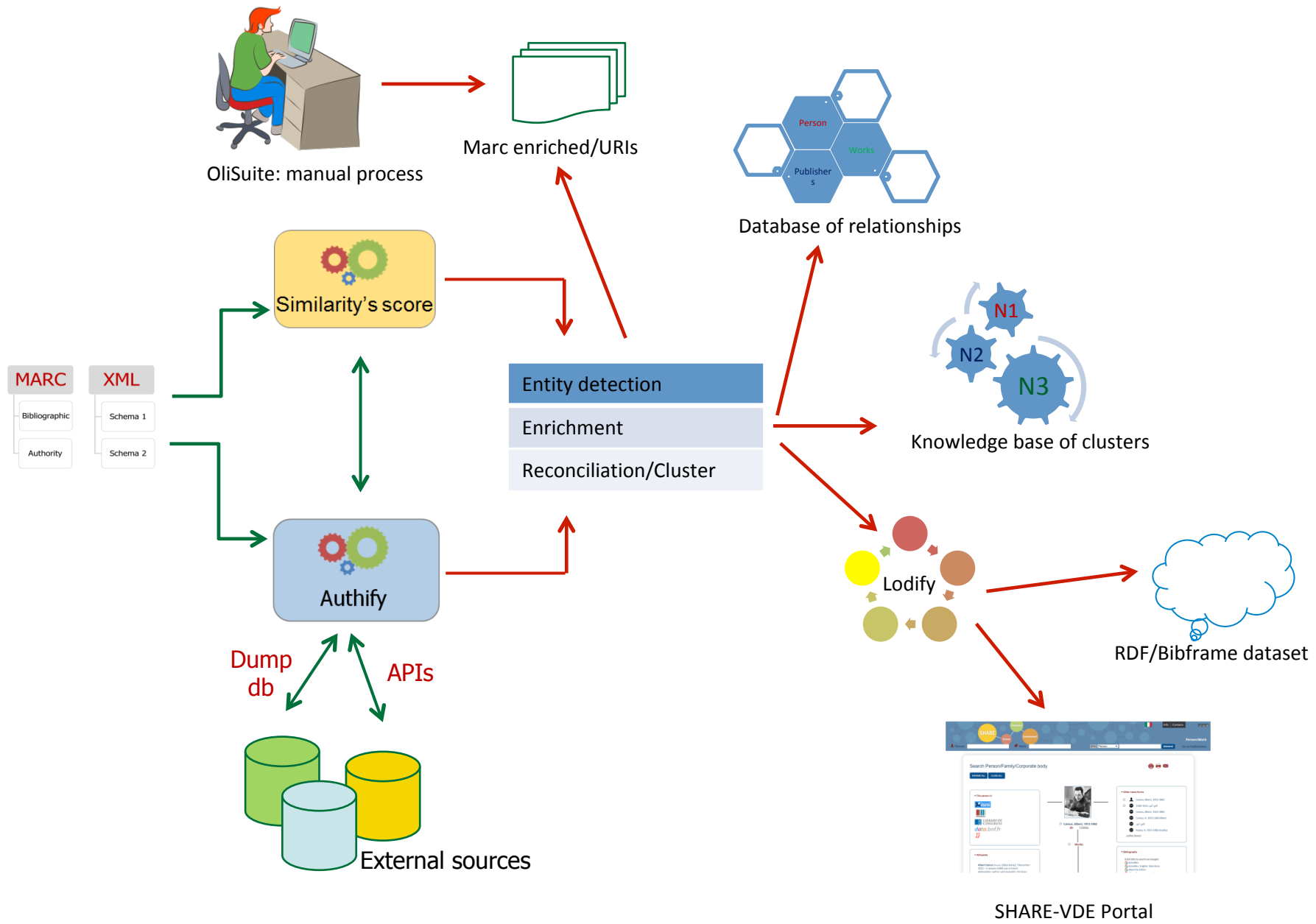

Focus on processes 1/2

Authority records



Bibliographic records

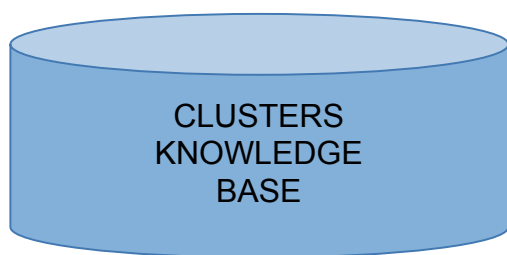
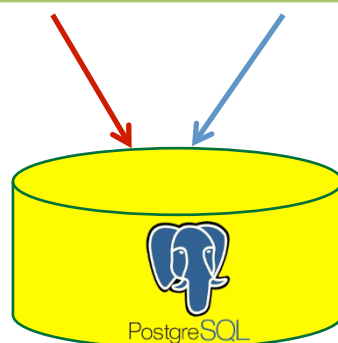
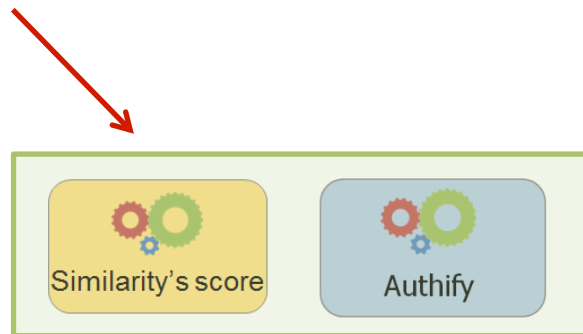

Marc enriched (.pxml)

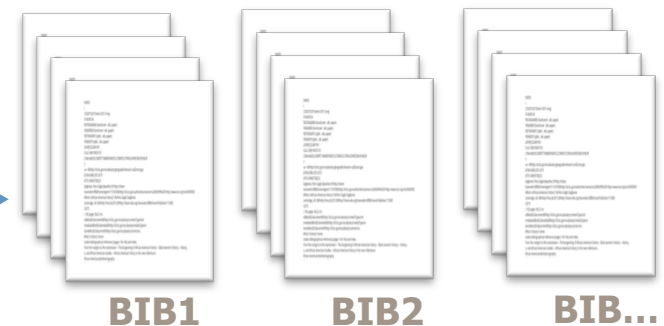

Focus on processes 2/2

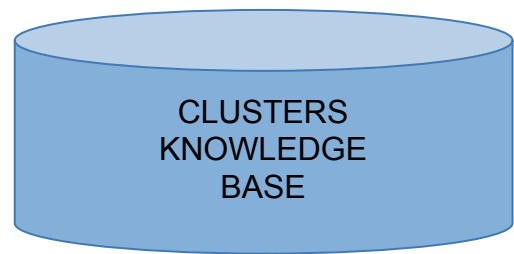

Marc enriched (.pxml)

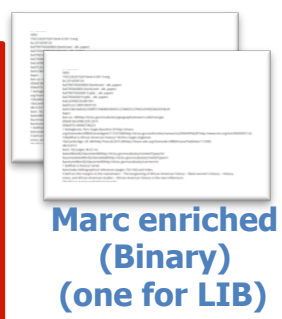
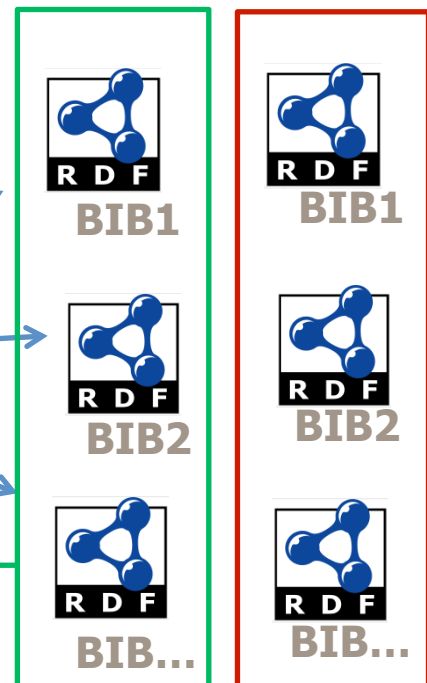
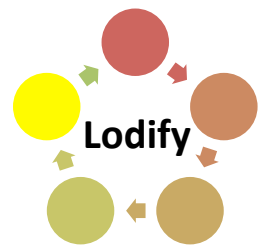
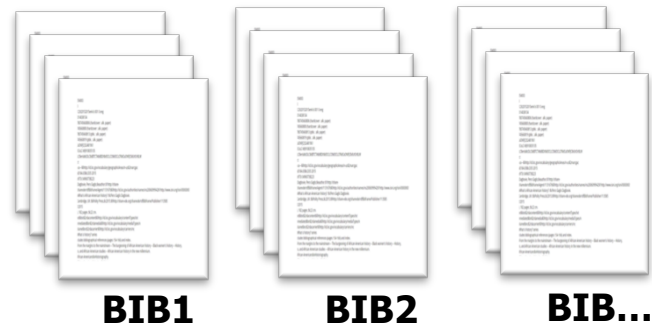

Clusters Knowledge base

SHARE-VDE URIs External (VIAF) URIs

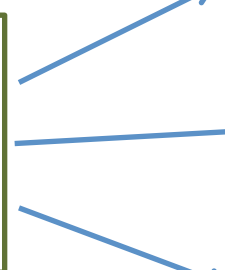
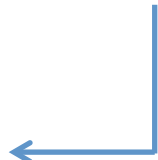

The project heart:

**Entity identification, Reconciliation,
Data enrichment
and
BIBFRAME Conversion**



The new revolution: from record to entity

Full Record	MARC Tags
	Where to Request
000	02384cam a2200445 a 4500
001	15789102
005	20100204124659.0
008	090624s2009 enka b 000 0 eng
010	__ a 2009025024
015	__ a GBA959347 2 bnb
016	7_ a 015291646 2 Uk
020	__ a 9780521519748 (hbk.)
020	__ a 0521519748 (hbk.)
020	__ a 9780521732505 (pbk.)
020	__ a 0521732506 (pbk.)
035	__ a (OCoLC)ocn416716652
040	__ a DLC c DLC d YDXCP d BWKUK d BWK d FDA d UKM d BTDTA d CEF d CDX d DLC
050	00 a PR2803.A2 b H35 2009
082	00 a 822.3/3 2 22
100	1_ a Shakespeare, William, d 1564-1616.
245	10 a As you like it / c edited by Michael Hattaway.
250	__ a Updated ed.
260	__ a Cambridge, UK ; a New York : b Cambridge University Press, c 2009.
300	__ a xv, 240 p. : b ill. ; c 24 cm.
490	1_ a New Cambridge Shakespeare
504	__ a Includes bibliographical references (p. 240).
505	0_ a Introduction. Journeys ; Plays within the play ; Theatrical genres ; Pastoral ; Counter-pastoral ; The condition of the country ; Politics ; 'Between you and the women the play must please' ; Gender ; Nuptials ; Sources ; Date and occasion ; Stage history ; Recent critical and stage interpretations -- Note on the text -- List of characters -- The play -- Textual analysis -- Appendixes : 1. An early court performance? ; 2. Extracts from Shakespeare's principal source, Lodge's Rosalind ; 3. The songs.
600	10 a Shakespeare, William, d 1564-1616. t As you like it .
650	_0 a Fathers and daughters v Drama.
650	_0 a Exiles v Drama.
655	_7 a Pastoral drama. 2 gsafd
655	_7 a Comedies. 2 gsafd
700	1_ a Hattaway, Michael.

As you like it [print]



Instance

As you like it [on-line]

Cambridge University Press

Cambridge Press



Publisher

Cambridge Univ. Press

Shakespeare, William, 1564-1616

Шекспир, У. 1564-1616 Уильям



Agent

Saixpēr, Gouilliam, 1564-1616

As you like it



Work

Come ti piace

Comme il vous plaira

Fathers and daughters



Subject

Padri e figlie

Pères et filles

How reconciliation is obtained

Scope of these processes is to bring together and to make data available from different sources in a way that could be defined as *democratic* to better identify the entity in question.

Data reconciliation and enrichment is obtained by:

- *automated processes*
- *manual processes*

It is important to underline how the **relationship between the reconciliation and validation of the results** can differ greatly between the automated and manual processes:

- automated processes: a high level of reconciliation and clustering; a low level of result validation;
- manual processes: a low level of reconciliation and clustering; a high level of result validation.





Massive clusters processes

- Authority headings analysis and process in PostgreSQL
- Data enrichment with external sources
- MARC bibliographic process
- Entity detection (authors and co-authors identification process)
- Name heading-to-Authority names association (through a weighted comparison algorithm)
- Name heading-to-Variant names association
- Cluster check (it exists = add; it doesn't exist = create new)

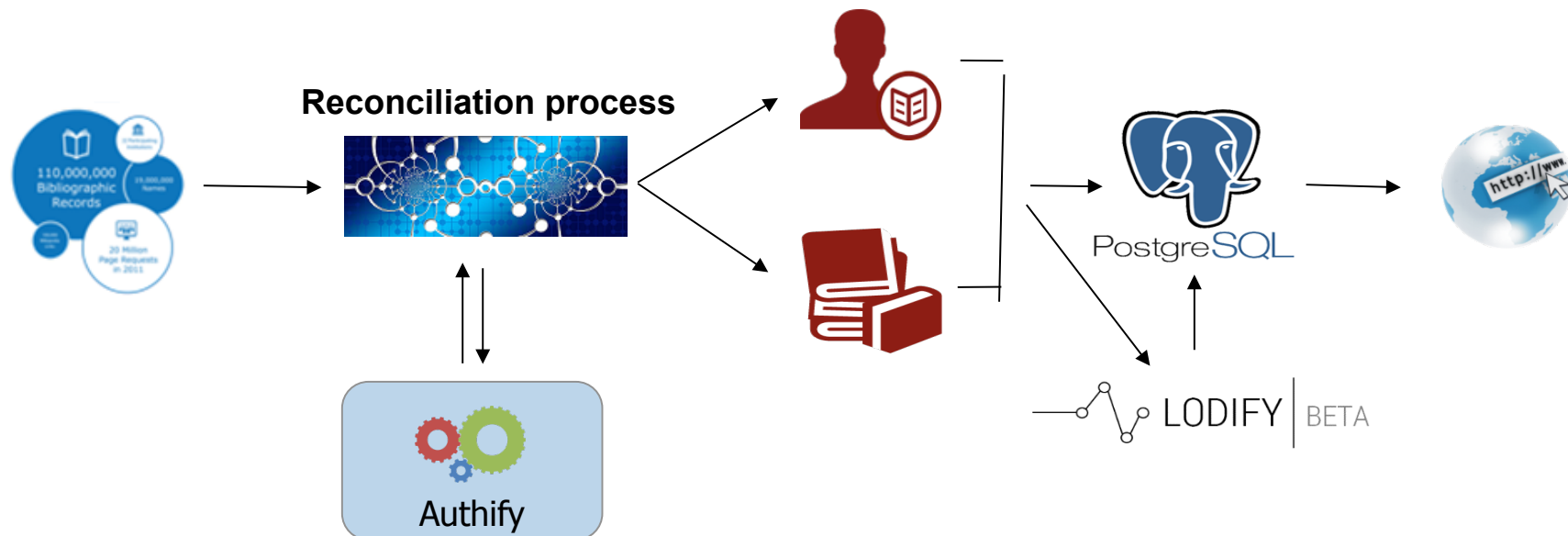

Entities in *cluster* : an example of collaboration and sharing

















Vivaldi, Antonio, 1678-1741
ID: 37154

▼ Questo autore in



▼ Altre forme del nome

-  Vivaldi, Antonio, 1678-1741
-  1678-1741, אנטוניו, ויולדי
-  Vivaldi, Antonio, 1678-1741
-  Vivaldi, Antonio
-  Vivaldi, Antonio, sac., 1678-1741
-  Вивальди, А. 1678-1741 АНТОНИО
-  Вивальди, АНТОНИО, 1678-1741
-  Vivaldi, Antonio, 1680-1741
-  1741-1678, فيفالدي, أنطونيو
-  Antonio Vivaldi compositore e violinista italiano esponente di spicco del tardo barocco veneziano
-  Vivaldi, Antonio, ca.1678-1741
-  Vivaldi, Antonio (Italian composer and musician, 1678-1741)
-  Prete rosso, 1678-1741
-  Vivaldis, A., 1678-1741
-  Vivaldi, A. (Antonio), 1678-1741
-  Vivarudi, Antonio, 1678-1741
-  Vivaldi, Antonio

...(altre forme)

The result of a reconciliation of the entity *Antonio Vivaldi* in the Share VDE project, with data from different sources and projects:

- the authorized form from a local authority file
- the variant forms originating from the references on the local authority records
- the variant forms originating from the VIAF
- the forms of the name used in the bibliographic records.

The cluster is completed and enriched with identifiers for the same entity, Antonio Vivaldi, from sources such as:

- Wikidata
- Library of Congress Name Authority File
- Data.bnf.fr
- VIAF



An example of Work/Instances reconciliation

Grouping under a single work title of the many publication titles in the catalogue for *Cimento dell'armonia e dell'invenzione*

Single work title

Brings together different publications/resources present in different catalogues.

The screenshot displays a list of publications under the heading "Pubblicazioni". The list includes:

- Concerto per oboe in do maggiore, RV 449 : (Concerto n. 12 de "Il cimento dell'armonia e dell'invenzione", op. 8)
- The four seasons : op. 8 no. 1-4
- The four seasons op. 8, nr. 1-4
- The four seasons, Op. 8, Nos. 1-4
- The four seasons
- Le quattro stagioni concertos for violin and orchestra op. 8 no. 1-4
- The four seasons op. 8, nos. 1-4
- Violin concerti Nos. 5-12 : from Il cimento dell'armonia e dell'invenzione, op. 8 ; Flute concerto in D major, RV 429 ; Cello concerto in B minor, RV 424
- Violin concertos op. 8, nos. 5, 6, 7, 8, 9, 10
- The four seasons Les quatre saisons = Die vier Jahreszeiten
- Le quattro stagioni = Die vier Jahreszeiten = The four seasons = Les quatre saisons
- Die vier Jahreszeiten = Les quatre saisons = The four seasons
- The four seasons Le quattro stagioni = Die vier Jahreszeiten = Les quatre saisons

On the right side of the interface, there is a red icon of a book and a box containing the title "Cimento dell'armonia e dell'invenzione" and the ID "11287". Below this box, the word "Creatori:" is visible.

http://share-vde.org/sharevde/searchTitles?t_cluster_id=11287

Lodify - Conversion templates

Lodify converts each incoming record by means of Conversion templates. Each template associates:

- a MARC record belonging to the incoming data-stream
- with a set of (conversion) rules associated with BIBFRAME vocabulary (here, two rules for tag 300a and tag 300c)

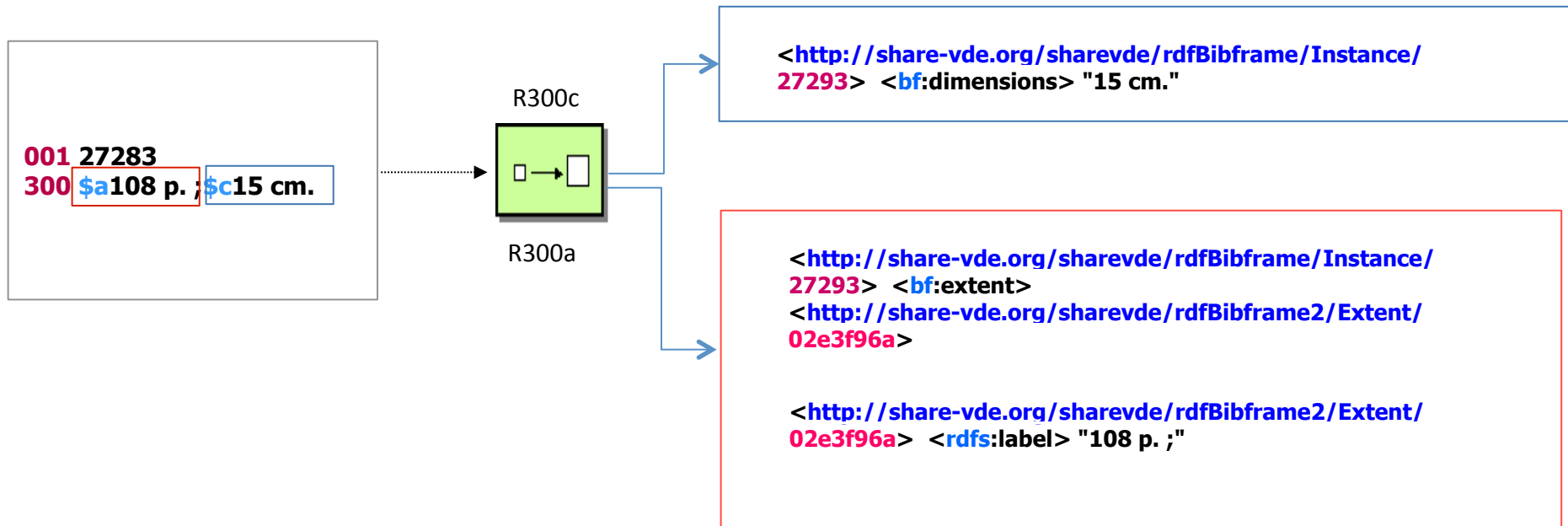

Lodify - Conversion templates

100 10\$aCastro, Juan Antonio.\$1http://share-vde.org/sharevde/rdfBibframe/Agent/1801277\$0http://id.loc.gov/authorities/names/n88638722\$1http://www.isni.org/isni/0000000059264386\$1http://www.wikidata.org/entity/Q21480742\$1http://viaf.org/viaf/63125720/

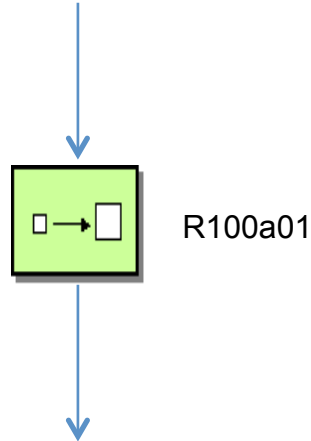

<http://share-vde.org/sharevde/rdfBibframe/Agent/1801277> <http://www.w3.org/1999/02/22-rdf-syntax-ns#type>
<bf:Person> .

<http://share-vde.org/sharevde/rdfBibframe/Agent/1801277> <rdfs:label> "Castro, Juan Antonio." .

<http://share-vde.org/sharevde/rdfBibframe/Agent/1801277> <bflc:name00MatchKey> "Castro, Juan Antonio." .

<http://share-vde.org/sharevde/rdfBibframe/Agent/1801277> <bflc:name00MarcKey> "10010\$aCastro, Juan Antonio.
\$1http://share-vde.org/sharevde/rdfBibframe/Agent/1801277 \$0http://id.loc.gov/authorities/names/n88638722
\$1http://www.isni.org/isni/0000000059264386 \$1http://www.wikidata.org/entity/Q21480742 \$1http://viaf.org/viaf/
63125720/" .

<http://share-vde.org/sharevde/rdfBibframe/Agent/1801277> <bflc:primaryContributorName00MatchKey> "Castro,
Juan Antonio." .

SHARE-VDE phase 2 deliverables



Phase 2 deliverables overview



BIB1



BIB2



BIB...

Deliverable 1: The datasets in BIBFRAME 2.0 of the entire catalogue of each institution with the "tuples" derived directly from the MARC records, delivered both as triples and as quadruples with the addition of the provenance and with Share-VDE URIs

SHARE-VDE URIs



Marc enriched
(Binary)
(one for LIB)

Deliverable 4: The MARC21 records for each institution enriched with URIs



BIB1



BIB2



BIB...

External (VIAF) URIs

Clusters Knowledge base

Deliverable 2: The knowledge base of clusters accessible in RDF

Deliverable 3: The datasets in BIBFRAME 2.0 for each institution with the triples that include the URIs from the external sources



Phase 2 deliverables overview

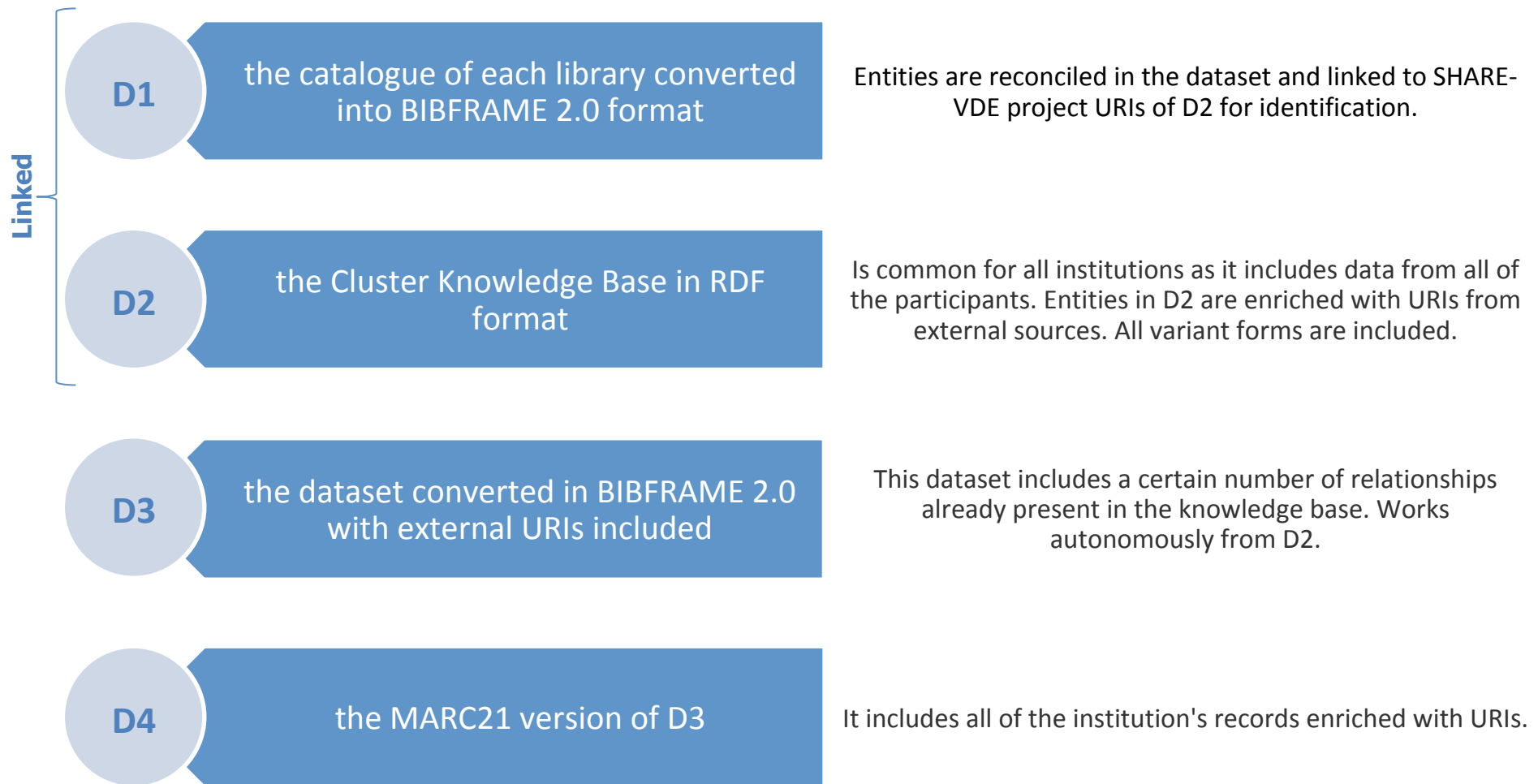

BF LC vocabulary extensions: the state-of-art

Class List

<u>AppliesTo</u>	<u>DemographicGroup</u>	<u>Relation</u>
<u>CreatorCharacteristic</u>	<u>EncodingLevel</u>	<u>Relationship</u>

Property List

<u>applicableInstitution</u>	<u>name10MatchKey</u>	<u>title00MarcKey</u>
<u>appliesTo</u>	<u>name11MarcKey</u>	<u>title00MatchKey</u>
<u>creatorCharacteristic</u>	<u>name11MatchKey</u>	<u>title10MarcKey</u>
<u>demographicGroup</u>	<u>primaryContributorName00MatchKey</u>	<u>title10MatchKey</u>
<u>encodingLevel</u>	<u>primaryContributorName10MatchKey</u>	<u>title11MarcKey</u>
<u>metadataLicensor</u>	<u>primaryContributorName11MatchKey</u>	<u>title11MatchKey</u>
<u>name00MarcKey</u>	<u>projectedProvisionDate</u>	<u>title30MarcKey</u>
<u>name00MatchKey</u>	<u>relation</u>	<u>title30MatchKey</u>
<u>name10MarcKey</u>	<u>relationship</u>	<u>title40MarcKey</u>
		<u>title40MatchKey</u>
		<u>titleSortKey</u>



Deliverable 1: the RDF conversion (section of RDF conversion)

```
@prefix rdfs: <http://www.w3.org/2000/01/rdf-schema#> .
@prefix ns0: <http://id.loc.gov/ontologies/bflc/> .
@prefix ns1: <http://id.loc.gov/ontologies/bibframe/> .
@prefix ns2: <http://id.loc.gov/vocabulary/relators/> .
@prefix rdf: <http://www.w3.org/1999/02/22-rdf-syntax-ns#> .
@prefix ns3: <http://www.loc.gov/mads/rdf/v1#> .
<http://share-vde.org/sharevde/rdfBibframe2/Agent/LOC> rdfs:label "LOC" .
<http://id.loc.gov/authorities/names/n50044402>
  a <http://id.loc.gov/ontologies/bibframe/Agent>, <http://id.loc.gov/ontologies/bibframe/Person> ;
  rdfs:label "Bridget, approximately 1303-1373." ;
  ns0:name00MatchKey "Bridget, approximately 1303-1373." ;
  ns0:name00MarcKey "1000 $aBridget, $cof Sweden, Saint, $dapproximately 1303-1373. $0http://id.loc.gov/authorities/names/n50044402" ;
  ns0:primaryContributorName00MatchKey "Bridget, approximately 1303-1373." .
<http://id.loc.gov/authorities/names/n84007202>
  a <http://id.loc.gov/ontologies/bibframe/Work>, <http://id.loc.gov/ontologies/bibframe/Text> ;
  ns1:title <http://share-vde.org/sharevde/rdfBibframe2/Title/a0f4e860-c259-3611-b7ca-03b9369568cb>, <http://share-vde.org/sharevde/rdfBibframe2/uniform-title/a0f4e860-c259-3611-b7ca-03b9369568cb> ;
  ns2:cre <http://id.loc.gov/authorities/names/n50044402> ;
  ns1:content <http://rdaregistry.info/termList/RDAContentType/1020>, <http://id.loc.gov/vocabulary/contentTypes/txt> ;
  ns1:adminMetadata <http://share-vde.org/sharevde/rdfBibframe2/AdminMetadata/4a8a08f0-9d37-3737-9564-9038408b5f33> ;
  ns1:language <http://id.loc.gov/vocabulary/languages/eng>, <http://share-vde.org/sharevde/rdfBibframe2/Language/74e6a8b1-11ea-3da1-a7d0-a596f4c35208> ;
  ns1:genreForm <http://id.loc.gov/vocabulary/marctg/bib> ;
  ns1:classification <http://share-vde.org/sharevde/rdfBibframe2/Lcc/842e73eb-0d86-374b-a4bd-dae01b30c68a> ;
  ns1:subject <http://share-vde.org/sharevde/rdfBibframe2/Subject/6c09b127-ac1a-3428-ad6e-f896dbf69260>, <http://share-vde.org/sharevde/rdfBibframe2/Subject/2f1b63c0-98ed-35e9-b57b-f7d7ce7c525d> .
```

LC vocabulary extension



Deliverable 1: the RDF conversion (section of RDF conversion)

```
<http://share-vde.org/sharevde/rdfBibframe2/Title/a0f4e860-c259-3611-b7ca-03b9369568cb> rdfs:label "Revelationes."  
<http://share-vde.org/sharevde/rdfBibframe2/uniform-title/a0f4e860-c259-3611-b7ca-03b9369568cb>  
  a ns1:Title ;  
  rdfs:label "Revelationes." ;  
  ns0:titleSortKey "Revelationes." ;  
  ns1:mainTitle "Revelationes." ;  
  ns0:title40MatchKey "Revelationes." ;  
  
  ns0:title40MarcKey "24010$aRevelationes. $lEnglish $s(Searby) $0http://id.loc.gov/authorities/names/n84007202" .  
  
<http://share-vde.org/sharevde/rdfBibframe2/Instance/LOC13910411>  
  ns1:instanceOf <http://id.loc.gov/authorities/names/n84007202> ;  
  ns1:issuance <http://id.loc.gov/vocabulary/issuance/mono> ;  
  ns1:adminMetadata <http://share-vde.org/sharevde/rdfBibframe2/AdminMetadata/ad1517aa-fe91-3d10-902c-a0de7cbd787e> ,  
<http://share-vde.org/sharevde/rdfBibframe2/AdminMetadata/4abffffde-8e4b-3806-b70a-e5c95af4f221> , <http://share-vde.org/  
sharevde/rdfBibframe2/AdminMetadata/11d5ffba-c1cd-3077-a2f5-aeb0b1fdc4f9> ;  
  ns1:contribution <http://share-vde.org/sharevde/rdfBibframe2/Contribution/8cd47f23-58b9-3a8c-b1f9-4627fca86c1a> ,  
<http://share-vde.org/sharevde/rdfBibframe2/Contribution/e3d5c3a8-560a-3737-a105-dc7a4e8eadba> ;  
  a ns1:Instance ;  
  ns1:media <http://rdaregistry.info/termList/RDAMediaType/1007> , <http://id.loc.gov/vocabulary/mediaTypes/n> ;  
  ns1:carrier <http://rdaregistry.info/termList/RDACarrierType/1049> , <http://id.loc.gov/vocabulary/carriers/nc> ;  
  ns1:title <http://share-vde.org/sharevde/rdfBibframe2/title-statement/1835091e-3641-34e6-b0c5-fe64446acc12> ;  
  ns1:dimensions "25 cm" ;  
  ns1:extent <http://share-vde.org/sharevde/rdfBibframe2/Extent/0d4d8bca-a46a-3701-874b-8c45a15205c7> ;  
  ns1:note <http://share-vde.org/sharevde/rdfBibframe2/Note/2165960f-7bd9-3e33-b926-23c0de8c9765> , <http://share-  
vde.org/sharevde/rdfBibframe2/Note/92ace715-99d1-30a5-bca0-aec0d55a14ec> ;  
  ns1:responsibilityStatement "translated by Dennis Searby with Introduction and Notes By Bridget Morris." ;  
  ns1:provisionActivity <http://share-vde.org/sharevde/rdfBibframe2/ProvisionActivity/  
0c8dec7d-3f14-30cb-8074-7049da6859f9> ;
```



Deliverable 2: the Cluster Knowledge Base

An example of clusterization algorithms

Clusterization of "forename" heading type

Example:

"\$aBridget,\$cof Sweden, Saint,\$dapproximately 1303-1373"

- 1) selections of interesting subfield
- 2) normalization of string text without diacritics, accents: Bridget of Sweden Saint approximately 1303-1373.
- 3) translate all in uppercase and search string into db variant forms and cross references:
BRIDGET OF SWEDEN SAINT APPROXIMATELY 1303-1373
- 4) if no cluster found, subfields will be analyzed
 - 4.1 comparing \$a with other existing forms
 - 4.2 comparing only the numeric part of \$d (having same \$a): \$dapproximately 1303-1373 => \$d1303-1373
 - 4.3 comparing \$c for "saint" or "santa" or other forms (having same \$a)

Deliverable 2: the Cluster Knowledge Base

PostgreSQL as a bridge

<input type="checkbox"/>	clstr_id integer	hdg_id text	name text	pref_frm boolean
<input type="checkbox"/>	151177	AN163420	Bridget, of Sweden, Saint, approximately 1303-1373	false
<input type="checkbox"/>	151177	AX1253673	Bridget, of Sweden, Saint, approximately 1303-1373. ...	false
<input type="checkbox"/>	151177	AX1253674	Bridget, of Sweden, Saint, approximately 1303-1373. ...	false
<input type="checkbox"/>	151177	AX1253675	Bridget, of Sweden, Saint, approximately 1303-1373. ...	false
<input type="checkbox"/>	151177	AX1253676	Bridget, of Sweden, Saint, ca. 1303-1373. Uppenbarel...	false
<input type="checkbox"/>	151177	AX1253677	Bridget, of Sweden, Saint, ca. 1303-1373. Reuelation...	false
<input type="checkbox"/>	151177	AX1326216	Bridget, of Sweden, Saint, approximately 1303-1373. ...	false
<input type="checkbox"/>	151177	AX1326217	Bridget, of Sweden, Saint, ca. 1303-1373. Revelaciones	false
<input type="checkbox"/>	151177	AX186404	Birgitt, of Sweden, Saint, approximately 1303-1373	false
<input type="checkbox"/>	151177	AX186405	Birgitta Birgersdotter, approximately 1303-1373	false
<input type="checkbox"/>	151177	AX186406	Birgitta, of Sweden, Saint, approximately 1303-1373	false
<input type="checkbox"/>	151177	AX186407	Birgitta, Saint, of Sweden, d. 1373	false
<input type="checkbox"/>	151177	AX186408	Birgitta, von Schweden, Saint, approximately 1303-13...	false
<input type="checkbox"/>	151177	AX186409	Bridget, of Sweden, Saint, ca. 1303-1373	false
<input type="checkbox"/>	151177	AX186410	Brigid, of Sweden, Saint, approximately 1303-1373	false
<input type="checkbox"/>	151177	AX186411	Brigida, di Svezia, approximately 1303-1373	false
<input type="checkbox"/>	151177	AX186412	Brigida, of Sweden, Saint, approximately 1303-1373	false
<input type="checkbox"/>	151177	AX186413	Brigitta, of Sweden, Saint, approximately 1303-1373	false
<input type="checkbox"/>	151177	AX186414	Brigitte, de Suède, Saint, approximately 1303-1373	false
<input type="checkbox"/>	151177	AX186415	Brigitte, of Sweden, Saint, approximately 1303-1373	false

Deliverable 2: the Cluster Knowledge Base

The final result

▼ This person in



Birgitta, helgon, 1303-1373

ID: 151177

Works

▼ Other name forms

- Bridget, of Sweden, Saint, approximately 1303-1373
- Brigida, de Suêcia, santa, 1303-1373
- Brigitta, s., vidua, c. 1303-1373
- Brigita, Zviedrijas, Svētā, ap 1303-1373
- Bridget, of Sweden, Saint, approximately 1303-1373
- Birgitta святая 1303-ок.1373
- Birgitta, de Suède, sainte
- Brigida 1303-1373 de Suêcia, santa
- Bridget, of Sweden, Saint, ca. 1303-1373
- Brygida (sw. ; 1302-1373)
- Birgitta, of Sweden, Saint, approximately 1303-1373
- Birgitta, Saint, of Sweden, d. 1373
- Birgitta, von Schweden, Saint, approximately 1303-1373
- Brigitta, of Sweden, Saint, approximately 1303-1373
- Brigitte, de Suède, Saint, approximately 1303-1373
- Bride, of Sweden, Saint, ca.

<http://share-vde.org/sharevde/rdfBibframe/Agent/151177>

rdfs:label "Bridget, of Sweden, Saint, approximately 1303-1373. Puch der himlischen Offenbarung der heiligen Wittiben Birgitte von dem Königreich Sweden", "Birgitta Suecica 1303-1373", "Bridget, of Sweden, Saint, ca. 1303-1373. Revelationes", "Brigida, of Sweden, Saint, approximately 1303-1373", "Birgitta Birgersdotter, approximately 1303-1373", "Birgitta, of Sweden, Saint, approximately 1303-1373", "Bridget, of Sweden, Saint, approximately 1303-1373. Liber celestis of St. Bridget of Sweden", "Bridget, of Sweden, Saint, approximately 1303-1373. Revelations", "Birgitta, Saint, of Sweden, d. 1373", "Bridget, of Sweden, Saint, approximately 1303-1373. Saint Bride and her book", "Brigida da Suêcia, Santa, 1303-1373", "Birgitta, helgon, 1303-1373", "Bridget, of Sweden, Saint, ca. 1303-1373", "Bridget, of Sweden, Saint, approximately 1303-1373. Reuelationes celestes praelecte sponse Christi beate Birgitte vidue de regno Suecie", "Bridget, of Sweden, Saint, ca. 1303-1373. Selections", "Brigida, de Suecia, Santa, Ca. 1303-1373", "Bridget, of Sweden, Saint, approximately 1303-1373. Revelations of Saint Birgitta", "Bridget, of Sweden, Saint, approximately 1303-1373. Brigida di Svezia", "Bridget, of Sweden, Saint, approximately 1303-1373", "Birgitta, von Schweden, Saint, approximately 1303-1373", "Bridget, of Sweden, Saint, ca. 1303-1373. Sermo angelicus", "Birgitta, ca. 1303-1373", "Bridget, of Sweden, Saint, approximately 1303-1373. Book V of St Birgitta's Uppenbarelsen" ;

<http://share-vde.org/sharevde/rdfBibframe/Agent/151177> <<http://www.w3.org/2002/07/owl#sameAs>> <<http://isni.org/isni/0000000121012842>> .
 <<http://share-vde.org/sharevde/rdfBibframe/Agent/151177>> <<http://www.w3.org/2002/07/owl#sameAs>> <<http://www.wikidata.org/entity/Q204996>> .
 <<http://share-vde.org/sharevde/rdfBibframe/Agent/151177>> <<http://www.loc.gov/mads/rdf/v1#isidentifiedByAuthority>> <<http://id.loc.gov/authorities/names/n50044402>> .



Deliverable 4: URIs table for external sources

SHARE-VDE

URI_table_for_external_sources_2017-12-22.xls

SPARQL endpoint	RDF dump	LICENSE TERMS	URL SEARCH	NOTES	AUTHIFY (Yes for search URL specified)	SUBFIELD \$0/\$1
	Yes		http://id.loc.gov/search/?q=Shakespeare+William&q=cs%3Ahttp%3A%2F%2Fid.loc.gov%2Fauthorities%2Fnames&format=atom&start=1		http://\$(host):\$(port)/authify/lcnaf/persons?q=Eco, Umberto	\$0
	Yes		http://id.loc.gov/search/?q=bible+old+testament&q=cs		http://\$(host):\$(port)/authify/lcnaf/works?title=Solomon	\$0

SHARE-VDE

URI_table_for_external_sources_2017-12-22.xls

2017-12-22

CODE	SOURCE	INSTITUTION	LINK TO PROJECT PAGE	URI	URI EXAMPLE	MARC21 TAG	API/WS
NAF (Names)	Library of Congress Names	Library of Congress	http://id.loc.gov/authorities/names.html	http://id.loc.gov/authorities/names	http://id.loc.gov/authorities/names/n78095332	100/110/111 \$0 700/710/711 \$0 600 \$0 ?	S/M
NAF (NameTitle + Titles)	Library of Congress Title / NameTitle	Library of Congress	http://id.loc.gov/authorities/names.html	http://id.loc.gov/authorities/names	http://id.loc.gov/authorities/names/nr00019197	100/110/111(\$t) \$0 700/710 600 \$0 \$0 730 \$	S/M
LCSH	Library of Congress Subject Headings	Library of Congress	http://id.loc.gov/authorities/subjects.html	http://id.loc.gov/authorities/subjects	http://id.loc.gov/authorities/subjects/sh90004917	6xx \$0	
LC Classification	Library of Congress Classifications	Library of Congress	http://id.loc.gov/authorities/classification.html	http://id.loc.gov/authorities/classification	http://id.loc.gov/authorities/classification/22784.P7		
LC Identifiers	Library of Congress Standard Identifiers Scheme	Library of Congress	http://id.loc.gov/vocabulary/identifiers.html	http://id.loc.gov/vocabulary/identifiers	http://id.loc.gov/vocabulary/identifiers/isbn		
Geographic Areas	MARC List for Geographic Areas	Library of Congress	http://id.loc.gov/vocabulary/geographicAreas.html	http://id.loc.gov/vocabulary/geographicAreas	http://id.loc.gov/vocabulary/geographicAreas/e-it	043 \$0	
Relators	MARC Code List for Relators	Library of Congress	http://id.loc.gov/vocabulary/relators.html	http://id.loc.gov/vocabulary/relators	http://id.loc.gov/vocabulary/relators/cre	1xx-7xx	
Languages	MARC List for Languages	Library of Congress	http://id.loc.gov/vocabulary/languages.html	http://id.loc.gov/vocabulary/languages	http://id.loc.gov/vocabulary/languages/ita	041 ?	
Countries	MARC List for Countries	Library of Congress	http://id.loc.gov/vocabulary/countries.html	http://id.loc.gov/vocabulary/countries	http://id.loc.gov/vocabulary/countries/it	?	
ISNI	ISNI - International Standard Name Identifier	OCLC	http://isni.org/search	http://isni.org/isni/[ID]	http://isni.org/0000000121032683 http://isni.org/0000000109205182	100/1103 700/710 600 \$1 ? 2	
VIAF (Names)	VIAF - Virtual International Authority File	OCLC	http://viaf.org/	http://viaf.org/viaf/id	http://viaf.org/viaf/96994048	100/110 700/710 600 \$1 ?	

SHARE-VDE

URI			
http://id.loc.gov/authorities/names/n79021285			
http://id.loc.gov/authorities/names/n80106714			
http://id.loc.gov/authorities/names/nr00019197			
http://id.loc.gov/authorities/subjects/sh85037601			
http://id.loc.gov/vocabulary/geographicAreas/a-ko			
http://id.loc.gov/vocabulary/relators/aut			
http://isni.org/isni/0000000120981297			
http://viaf.org/viaf/14356			

Deliverable 4: the enriched MARC21

Record example: <http://id.loc.gov/tools/bibframe/compare-id/full-ttl?find=13910411>

[Original record]

```
01996cam a2200421 i 4500
001 13910411
005 20161026123523.0
008 050324s2015 nyua b 001 0 eng
010 $a 2005047277
020 $a9780195166446 (v.1)
020 $a9780195166262 (v.2)
020 $a9780195166279 (v.3)
020 $a9780195166286 (v.4)
040 $aDLC$beng$cDLC$erda
041 1 $aeng$hlat
042 $apcc
050 00 $aBX4700.B62$bE5 2006
100 0 $aBridget,$cof Sweden, Saint,$dapproximately 1303-1373.
240 10 $aRevelationes.$lEnglish$s (Searby)
245 14 $aThe revelations of St. Birgitta of Sweden Volume 4 : the heavenly emperor's book to kings, the rule, and minor works /$ctranslated by Dennis Searby with Introduction and Notes By Bridget Morris.
264 1 $aOxford :$bOxford University Press,$c2006-[2015]
300 $a4 volumes :$billustrations ;$c25 cm
```



Deliverable 4: the enriched MARC21

Record example: <http://id.loc.gov/tools/bibframe/compare-id/full-ttl?find=13910411>

[Original record]

```
336 $atext$btxt$2rdacontent
337 $aunmediated$bn$2rdamedia
338 $avolume$bnc$2rdacarrier
504 $aIncludes bibliographical references and index.
505 0 $av. 1. Liber Caelestis, books I-III -- v. 2. Liber Caelestis, books IV-V -- v. 3. Liber Caelestis, books VI-VII
-- v. 4. The heavenly emperor's book to kings, the rule, and minor works.
650 0 $aPrivate revelations.
650 0 $aVisions.
700 1 $aSearby, Denis Michael,$etranslator.
700 1 $aMorris, Bridget,$d1954-$ewriter of supplementary textual content.
906 $a0$bibc$corignew$d2$encip$f20$gy-gencatlg
925 0 $aacquire$b1 shelf copy$xpolicy default
952 $aComplete in 4 vols.
955 $brm08 2016-06-06 (Telework)
955 $apcl6 2005-03-24 to HLCD$csh21 2005-03-30$dsh13 2005-03-31$esh42 2005-04-04 to Dewey$aaa05 2005-04-06$aps12
2006-07-19 1 copy rec'd., to CIP ver.$fpv17 2006-08-03 Z-CipVer$arc09 2009-06-25 v. 2 added$trf13 2009-07-27 c. 2, v. 2
to BCCD
955 $aADDED VOLS: v. 3 xn05 2012-4-5 to USGEN
955 $aADDED VOLS: v. 4 xn12 2015-12-01 to USASH
```



Deliverable 4: the enriched MARC21

Record example: <http://id.loc.gov/tools/bibframe/compare-id/full-ttl?find=13910411>

[The same record enriched with URIs]

```
=LDR 02447cam a2200421 i 4500
=001 13910411
=005 20161026123523.0
=008 050324s2015\\n\\nyua\\b\\001\0\eng\\
=010 \\$a 2005047277
=020 \\$a9780195166446 (v.1)
=020 \\$a9780195166262 (v.2)
=020 \\$a9780195166279 (v.3)
=020 \\$a9780195166286 (v.4)
=040 \\$aDLC$beng$cDLC$erda
=041 1$aeng$hlat
=042 \\$apcc
=050 00$aBX4700.B62$bE5 2006
=100 0$aBridget,$cof Sweden, Saint,$dapproximately 1303-1373.
$0http://id.loc.gov/authorities/names/n50044402
=240 10$aRevelationes.$lEnglish$s (Searby) $0http://id.loc.gov/authorities/names/n84007202
=245 14$aThe revelations of St. Birgitta of Sweden Volume 4 : the heavenly emperor's book to kings, the
rule, and minor works /$ctranslated by Dennis Searby with Introduction and Notes By Bridget Morris.
=264 \1$aOxford :$bOxford University Press,$c2006-[2015]
=300 \\$a4 volumes :$billustrations ;$c25 cm
```



Deliverable 4: the enriched MARC21

Record example: <http://id.loc.gov/tools/bibframe/compare-id/full-ttl?find=13910411>

[The same record enriched with URIs]

```
=336  \\\$atext$btxt$2rdacontent$0http://rdaregistry.info/termList/RDAContentType/1020
=337  \\\$aunmediated$bn$2rdamedia$0http://rdaregistry.info/termList/RDAMediaType/1007
=338  \\\$avolume$bnc$2rdacarrier$0http://rdaregistry.info/termList/RDACarrierType/1049
=504  \\\$aIncludes bibliographical references and index.
=505  0\\$av. 1. Liber Caelestis, books I-III -- v. 2. Liber Caelestis, books IV-V -- v. 3.
Liber Caelestis, books VI-VII -- v. 4. The heavenly emperor's book to kings, the rule, and minor works.
=650  \0\\$aPrivate revelations.$0http://id.loc.gov/authorities/subjects/sh85107042
=650  \0\\$aVisions.$0http://id.loc.gov/authorities/subjects/sh85143882
=700  1\\$aSearby, Denis Michael,$etranslator.$0http://id.loc.gov/authorities/names/nr98021028
=700  1\\$aMorris, Bridget,$dl1954-$ewriter of supplementary textual content.$0http://id.loc.gov/authorities/names/n92016617
=906  \\\$a0$bibc$scorignew$d2$encip$f20$gy-gencatlg
=925  0\\$aacquire$b1 shelf copy$xpolicy default
=952  \\\$aComplete in 4 vols.
=955  \\\$brm08 2016-06-06 (Telework)
=955  \\\$apc16 2005-03-24 to HLCD$csh21 2005-03-30$dsh13 2005-03-31$esh42 2005-04-04 to Dewey$aaa05
2005-04-06$aps12 2006-07-19 1 copy rec'd., to CIP ver.$fpv17 2006-08-03 Z-CipVer$arc09 2009-06-25 v. 2
added$trf13 2009-07-27 c. 2, v. 2 to BCCD
=955  \\\$aADDED VOLS: v. 3 xn05 2012-4-5 to USGEN
=955  \\\$aADDED VOLS: v. 4 xn12 2015-12-01 to USASH
```



LODIFY Maturity Level

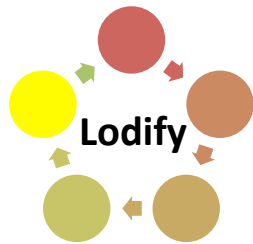

Lodify is the framework that automates the conversion and publication of bibliographic and authority data in RDF according to BIBFRAME 2.0 ontology in a linearly scalable way.

It works strictly in conjunction with other tools and components such as **Authify**, the **Database of relationships** and the **Clusters Knowledge Base (CKB)**.

Lodify contains the **conversions rules** from Marc21 to Bibframe 2.0, following the public mapping published on the LC site.

Lodify is flexible and adaptable to multiple situations: it allows, therefore, to manage the classes and properties not only of BF but also of ontologies that are considered integrative of the project.

LODIFY Maturity Level

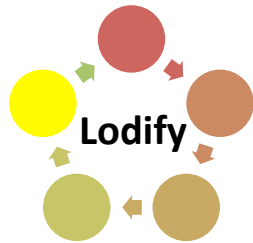

Data conversion and analysis:

- During this phase we analyzed a file of 690 RDA BIBCO Standard Records produced by Casalini Libri for LC (file belonging to the SHELF-READY workflow).
- This file was converted taking into account the rules of the Deliverable 3.
- These 690 records are used to determinate the maturity status of LODIFY.



LODIFY Maturity Level

OUTCOMES:

TAG MARC	VALUE	INDICATOR	SUBFIELD	CONVERTED IN BIBFRAME (@Cult)	CONVERTED IN BIBFRAME (LOC)
000/05				Y	Y
000/06	a			Y	Y
000/7	m			Y	Y
000/8	#			N	N (ignore)
000/08	a			Y	Y
000/09				N	N (ignore)
000/10				N	N (ignore)
000/11				N	N (ignore)
000/12-16				N	N (ignore)

a	Y	Y
b	N	N
n	N	N
d	N	N
c	N	N
e	Y (we use the relator term, not the URI)	Y (different from LOC)
0	Y	Y
a	Y	Y
n	N	N
d	N	N
c	N	N
a	Y	Y
0	Y	Y
1	Y	Y
4	N	N (nac???)
1	N	N
856	3	Y
	u	Y
MANAGED 40 TAGS		
MANAGED 23 VALUE POSITIONS OF TAG 000 AND 008		
MANAGED 106 SUBFIELDS		

Analysis result:

- Managed and converted **40** tags on 41 found in all records
- Managed and converted **23** value positions of tags 000 and 008
- Managed and converted **106** subfields



What comes next?



Looking backward to built the future

The **outputs of phase 2** is something that librarians and technicians can have 'in hands' to start a concrete experience and a discussion about them.

The **use cases** we are thinking about or that we are working on were born from two different exigencies:

- a. **to cover a gap** or an empty space that comes from the past, such as how to convert lots of data already in MARC through batch conversion processes;
- b. **to create a new ecosystem**, that is already the future, such as new tools to produce data in LD.

Emphasis is given on **short phases**, with **tangible results**, on which the community can base future decisions and further steps.

BIBFRAME Update Forum
ALA Annual Conference 2018
New Orleans

Thank you!

Any questions or feedback are greatly
appreciated

Tiziana Possemato
Casalini Libri - @Cult



SHARE

Virtual

Discovery

Environment